

# Complementary Silicon High-Power Transistors

... designed for general-purpose power amplifier and switching applications.

- Low Collector-Emitter Saturation Voltage —  
 $V_{CE(sat)} = 1.0 \text{ Vdc}$ , (max) at  $I_C = 15 \text{ Adc}$
- Low Leakage Current  
 $I_{CEX} = 1.0 \text{ mAdc}$  (max) at Rated Voltage
- Excellent DC Current Gain —  
 $h_{FE} = 20$  (min) at  $I_C = 10 \text{ Adc}$
- High Current Gain Bandwidth Product —  
 $f_T = 4.0 \text{ MHz}$  (min) at  $I_C = 1.0 \text{ Adc}$

## MAXIMUM RATINGS (1)

Rating	Symbol	2N5883 2N5885	2N5884 2N5886	Unit
Collector-Emitter Voltage	$V_{CEO}$	60	80	Vdc
Collector-Base Voltage	$V_{CB}$	60	80	Vdc
Emitter-Base Voltage	$V_{EB}$	5.0		Vdc
Collector Current — Continuous Peak	$I_C$	25 50		Adc
Base Current	$I_B$	7.5		Adc
Total Device Dissipation @ $T_C = 25^\circ\text{C}$ Derate above $25^\circ\text{C}$	$P_D$	200 1.15		Watts W/ $^\circ\text{C}$
Operating and Storage Junction Temperature Range	$T_J, T_{stg}$	-65 to +200		$^\circ\text{C}$

## THERMAL CHARACTERISTICS

Characteristic	Symbol	Max	Unit
Thermal Resistance, Junction to Case	$\theta_{JC}$	0.875	$^\circ\text{C/W}$

(1) Indicates JEDEC registered data. Units and conditions differ on some parameters and re-registration reflecting these changes has been requested. All above values most or exceed present JEDEC registered data.

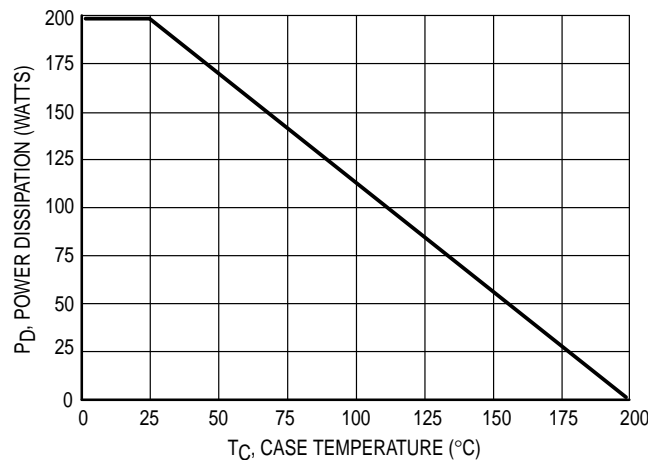

Figure 1. Power Derating

Preferred devices are Motorola recommended choices for future use and best overall value.

REV 7

**PNP**  
**2N5883**  
  
**2N5884\***  
**NPN**  
**2N5885**  
  
**2N5886\***

\*Motorola Preferred Device

**25 AMPERE**  
**COMPLEMENTARY**  
**SILICON**  
**POWER TRANSISTORS**  
**60-80 VOLTS**  
**200 WATTS**

**CASE 1-07**  
**TO-204AA**  
**(TO-3)**

**2N5883 2N5884 2N5885 2N5886**

**\*ELECTRICAL CHARACTERISTICS** ( $T_C = 25^\circ\text{C}$  unless otherwise noted)

Characteristic		Symbol	Min	Max	Unit
Collector–Emitter Sustaining Voltage (1) ( $I_C = 200\text{ mA}$ , $I_B = 0$ )	2N5883, 2N5885 2N5884, 2N5886	$V_{CE(sus)}$	60 80	— —	Vdc
Collector Cutoff Current ( $V_{CE} = 30\text{ Vdc}$ , $I_B = 0$ ) ( $V_{CE} = 40\text{ Vdc}$ , $I_B = 0$ )	2N5883, 2N5885 2N5984, 2N5886	$I_{CEO}$	— —	2.0 2.0	mAdc
Collector Cutoff Current ( $V_{CE} = 60\text{ Vdc}$ , $V_{BE(off)} = 1.5\text{ Vdc}$ ) ( $V_{CE} = 80\text{ Vdc}$ , $V_{BE(off)} = 1.5\text{ Vdc}$ ) ( $V_{CE} = 60\text{ Vdc}$ , $V_{BE(off)} = 1.5\text{ Vdc}$ , $T_C = 150^\circ\text{C}$ ) ( $V_{CE} = 80\text{ Vdc}$ , $V_{BE(off)} = 1.5\text{ Vdc}$ , $T_C = 150^\circ\text{C}$ )	2N5883, 2N5885 2N5884, 2N5886 2N5883, 2N5885 2N5884, 2N5886	$I_{CEX}$	— — 10 10	1.0 1.0	mAdc
Collector Cutoff Current ( $V_{CB} = 60\text{ Vdc}$ , $I_E = 0$ ) ( $V_{CB} = 80\text{ Vdc}$ , $I_E = 0$ )	2N5883, 2N5885 2N5884, 2N5886	$I_{CBO}$	— —	1.0 1.0	mAdc
Emitter Cutoff Current ( $V_{EB} = 5.0\text{ Vdc}$ , $I_C = 0$ )		$I_{EBO}$	—	1.0	mAdc

**ON CHARACTERISTICS**

DC Current Gain (1) ( $I_C = 3.0\text{ Adc}$ , $V_{CE} = 4.0\text{ Vdc}$ ) ( $I_C = 10\text{ Adc}$ , $V_{CE} = 4.0\text{ Vdc}$ ) ( $I_C = 25\text{ Adc}$ , $V_{CE} = 4.0\text{ Vdc}$ )	$h_{FE}$	35 20 4.0	— 100	—
Collector–Emitter Saturation Voltage (1) ( $I_C = 15\text{ Adc}$ , $I_B = 1.5\text{ Adc}$ ) ( $I_C = 25\text{ Adc}$ , $I_B = 6.25\text{ Adc}$ )	$V_{CE(sat)}$	— —	1.0 4.0	Vdc
Base–Emitter Saturation Voltage (1) ( $I_C = 25\text{ Adc}$ , $I_B = 6.25\text{ Adc}$ )	$V_{BE(sat)}$	—	2.5	Vdc
Base–Emitter On Voltage (1) ( $I_C = 10\text{ Adc}$ , $V_{CE} = 4.0\text{ Vdc}$ )	$V_{BE(on)}$	—	1.5	Vdc

**DYNAMIC CHARACTERISTICS**

Current–Gain — Bandwidth Product (2) ( $I_C = 1.0\text{ Adc}$ , $V_{CE} = 10\text{ Vdc}$ , $f_{test} = 1.0\text{ MHz}$ )	$f_T$	4.0	—	MHz
Output Capacitance ( $V_{CB} = 10\text{ Vdc}$ , $I_E = 0$ , $f = 1.0\text{ MHz}$ )	$C_{ob}$	— —	1000 500	pF
Small–Signal Current Gain ( $I_C = 3.0\text{ Adc}$ , $V_{CE} = 4.0\text{ Vdc}$ , $f_{test} = 1.0\text{ kHz}$ )	$h_{fe}$	20	—	—

**SWITCHING CHARACTERISTICS**

Rise Time	$(V_{CC} = 30\text{ Vdc}$ , $I_C = 10\text{ Adc}$ , $I_{B1} = I_{B2} = 1.0\text{ Adc}$ )	$t_r$	—	0.7	$\mu\text{s}$
Storage Time		$t_s$	—	1.0	$\mu\text{s}$
Fall Time		$t_f$	—	0.8	$\mu\text{s}$

\* Indicates JEDEC Registered Data.

(1) Pulse Test: Pulse Width  $\leq 300\ \mu\text{s}$ , Duty Cycle  $\leq 2.0\%$ . (2)  $f_T = |h_{fe}| \cdot f_{test}$ .

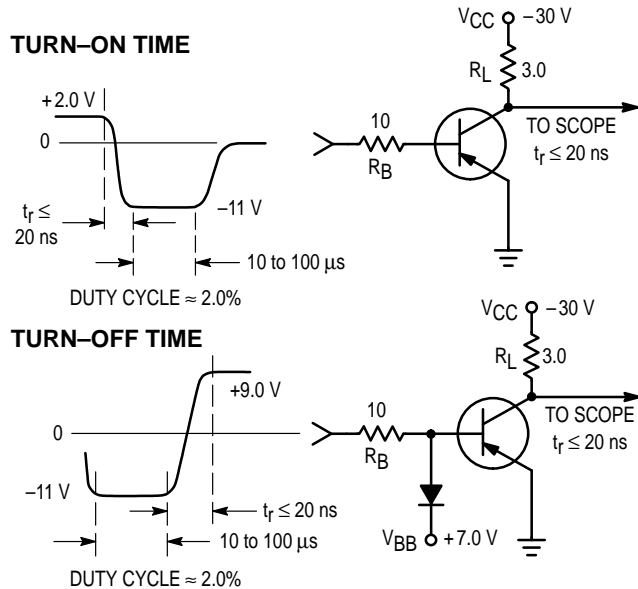

FOR CURVES OF FIGURES 3 & 6,  $R_B$  &  $R_L$  ARE VARIED.  
INPUT LEVELS ARE APPROXIMATELY AS SHOWN.  
FOR NPN, REVERSE ALL POLARITIES.

**Figure 2. Switching Time Equivalent Test Circuits**

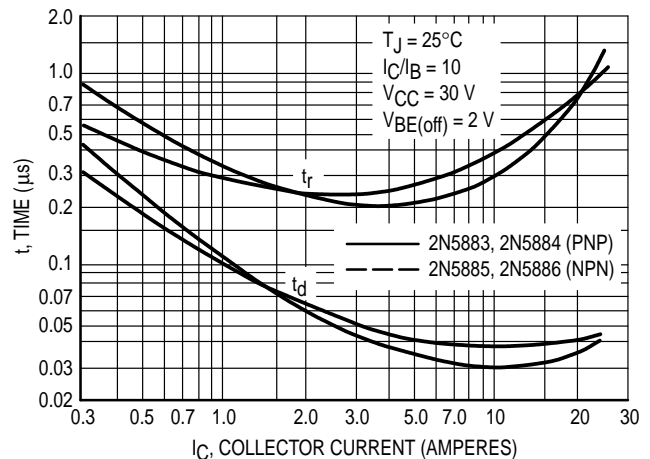

**Figure 3. Turn–On Time**

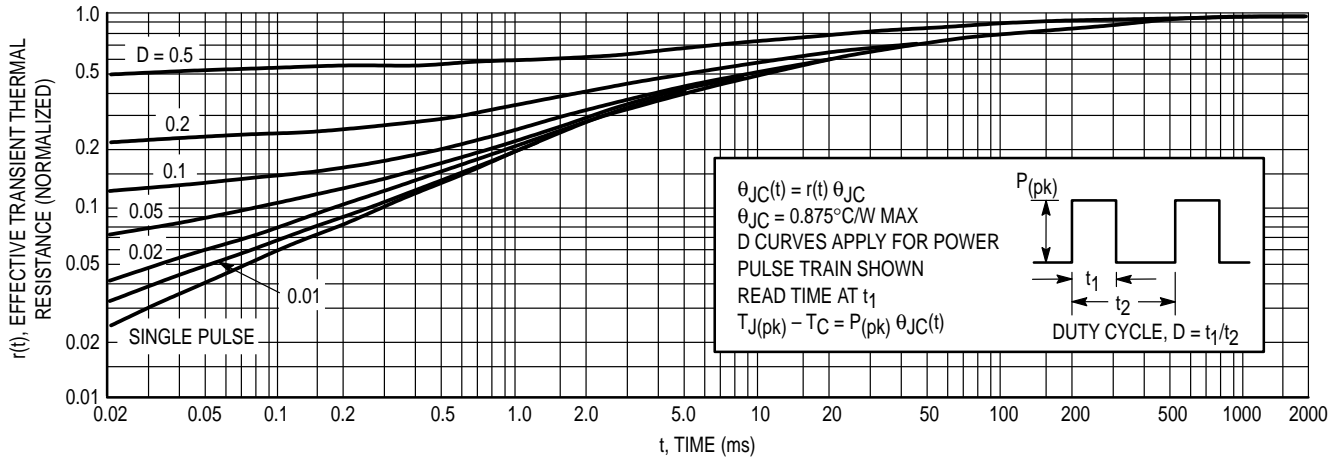

Figure 4. Thermal Response

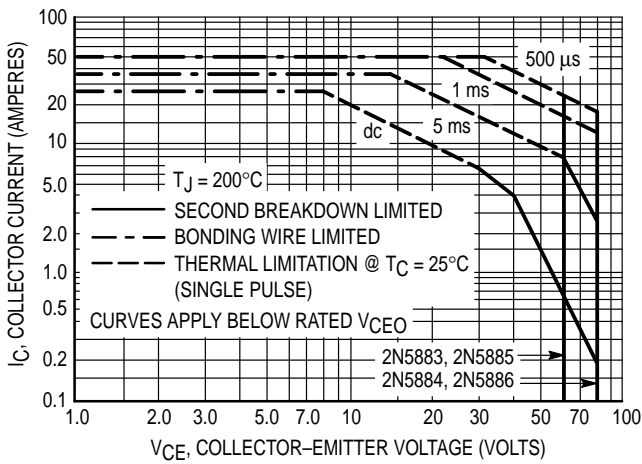

Figure 5. Active-Region Safe Operating Area

There are two limitations on the power handling ability of a transistor: average junction temperature and second breakdown. Safe operating area curves indicate  $I_C - V_{CE}$  limits of the transistor that must be observed for reliable operation; i.e., the transistor must not be subjected to greater dissipation than the curves indicate.

The data of Figure 5 is based on  $T_{J(pk)} = 200^{\circ}\text{C}$ ;  $T_C$  is variable depending on conditions. Second breakdown pulse limits are valid for duty cycles to 10% provided  $T_{J(pk)} \leq 200^{\circ}\text{C}$ .  $T_{J(pk)}$  may be calculated from the data in Figure 4. At high case temperatures, thermal limitations will reduce the power that can be handled to values less than the limitations imposed by second breakdown.

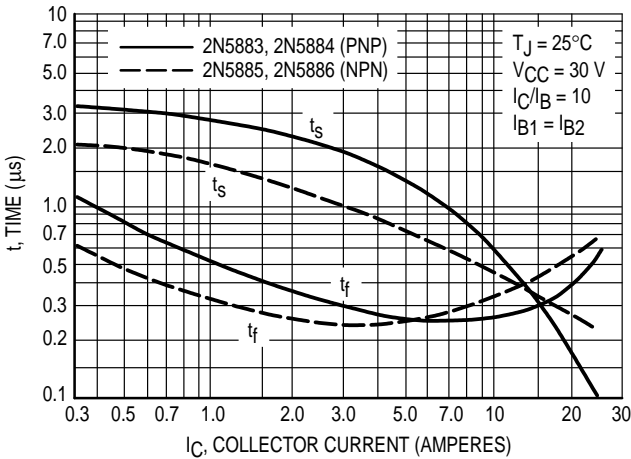

Figure 6. Turn-Off Time

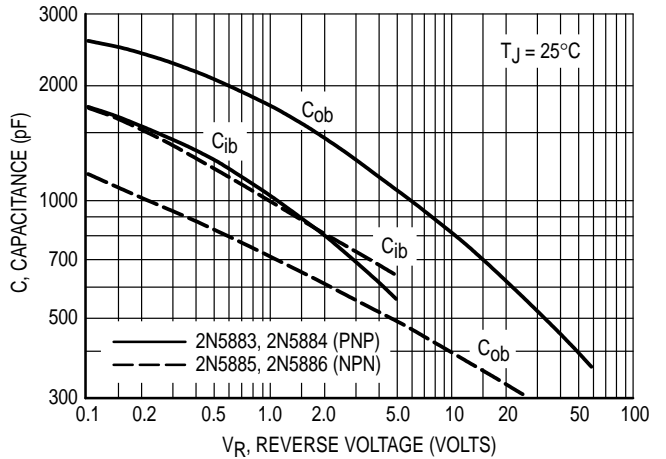
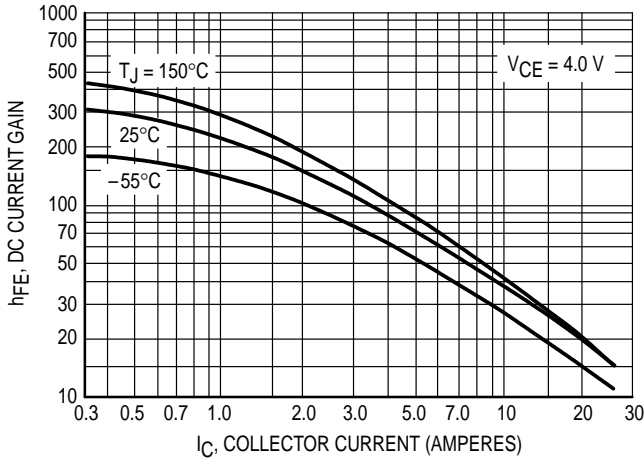

Figure 7. Capacitance

**PNP DEVICES**  
2N5883 and 2N5884



**NPN DEVICES**  
2N5885 and 2N5886

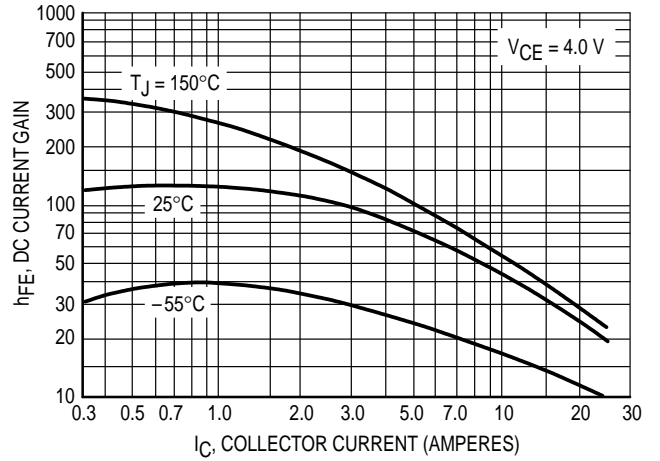

Figure 8. DC Current Gain

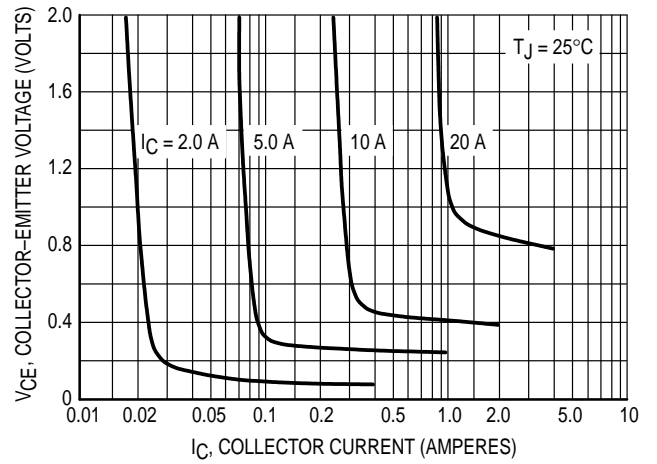
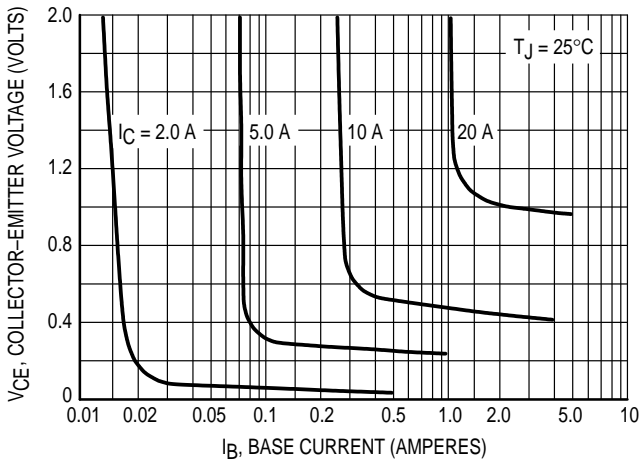

Figure 9. Collector Saturation Region

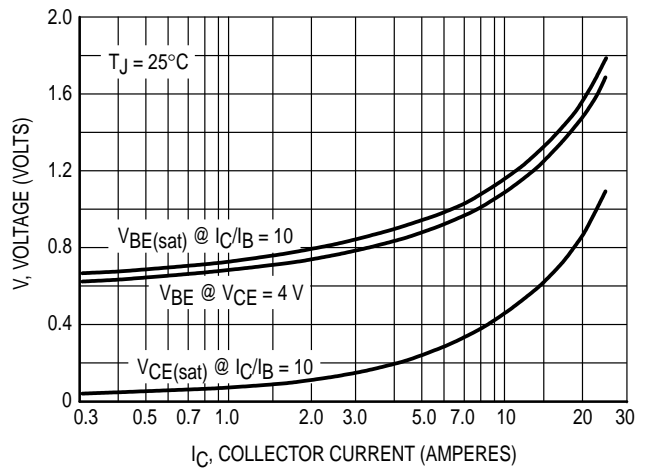
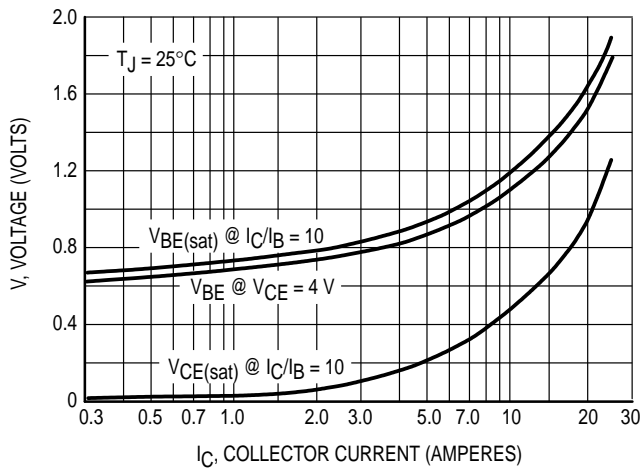
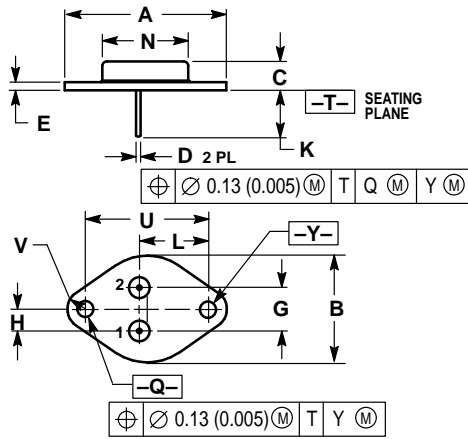

Figure 10. "On" Voltages

PACKAGE DIMENSIONS



- NOTES:
1. DIMENSIONING AND TOLERANCING PER ANSI Y14.5M, 1982.
  2. CONTROLLING DIMENSION: INCH.
  3. ALL RULES AND NOTES ASSOCIATED WITH REFERENCED TO-204AA OUTLINE SHALL APPLY.

DIM	INCHES		MILLIMETERS	
	MIN	MAX	MIN	MAX
A	1.550 REF		39.37 REF	
B	—	1.050	—	26.67
C	0.250	0.335	6.35	8.51
D	0.038	0.043	0.97	1.09
E	0.055	0.070	1.40	1.77
G	0.430 BSC		10.92 BSC	
H	0.215 BSC		5.46 BSC	
K	0.440	0.480	11.18	12.19
L	0.665 BSC		16.89 BSC	
N	—	0.830	—	21.08
Q	0.151	0.165	3.84	4.19
U	1.187 BSC		30.15 BSC	
V	0.131	0.188	3.33	4.77

STYLE 1:  
 PIN 1. BASE  
 2. EMITTER  
 CASE: COLLECTOR

CASE 1-07  
 TO-204AA (TO-3)  
 ISSUE Z

Motorola reserves the right to make changes without further notice to any products herein. Motorola makes no warranty, representation or guarantee regarding the suitability of its products for any particular purpose, nor does Motorola assume any liability arising out of the application or use of any product or circuit, and specifically disclaims any and all liability, including without limitation consequential or incidental damages. "Typical" parameters can and do vary in different applications. All operating parameters, including "Typicals" must be validated for each customer application by customer's technical experts. Motorola does not convey any license under its patent rights nor the rights of others. Motorola products are not designed, intended, or authorized for use as components in systems intended for surgical implant into the body, or other applications intended to support or sustain life, or for any other application in which the failure of the Motorola product could create a situation where personal injury or death may occur. Should Buyer purchase or use Motorola products for any such unintended or unauthorized application, Buyer shall indemnify and hold Motorola and its officers, employees, subsidiaries, affiliates, and distributors harmless against all claims, costs, damages, and expenses, and reasonable attorney fees arising out of, directly or indirectly, any claim of personal injury or death associated with such unintended or unauthorized use, even if such claim alleges that Motorola was negligent regarding the design or manufacture of the part. Motorola and  are registered trademarks of Motorola, Inc. Motorola, Inc. is an Equal Opportunity/Affirmative Action Employer.

**How to reach us:**

**USA / EUROPE:** Motorola Literature Distribution;  
P.O. Box 20912; Phoenix, Arizona 85036. 1-800-441-2447

**JAPAN:** Nippon Motorola Ltd.; Tatsumi-SPD-JLDC, Toshikatsu Otsuki,  
6F Seibu-Butsuryu-Center, 3-14-2 Tatsumi Koto-Ku, Tokyo 135, Japan. 03-3521-8315

**MFAX:** RMFAX0@email.sps.mot.com - TOUCHTONE (602) 244-6609  
**INTERNET:** <http://Design-NET.com>

**HONG KONG:** Motorola Semiconductors H.K. Ltd.; 8B Tai Ping Industrial Park,  
51 Ting Kok Road, Tai Po, N.T., Hong Kong. 852-26629298

