

50 kPa On-Chip Temperature Compensated & Calibrated Silicon Pressure Sensors

The MPXM2053 device is a silicon piezoresistive pressure sensor providing a highly accurate and linear voltage output — directly proportional to the applied pressure. The sensor is a single, monolithic silicon diaphragm with the strain gauge and a thin-film resistor network integrated on-chip. The chip is laser trimmed for precise span and offset calibration and temperature compensation.

Features

- Temperature Compensated Over 0°C to +85°C
- Unique Silicon Shear Stress Strain Gauge
- Easy to Use Tape & Reel
- Ratiometric to Supply Voltage
- Gauge Ported & Non Ported Options

Figure 1 shows a block diagram of the internal circuitry on the stand-alone pressure sensor chip.

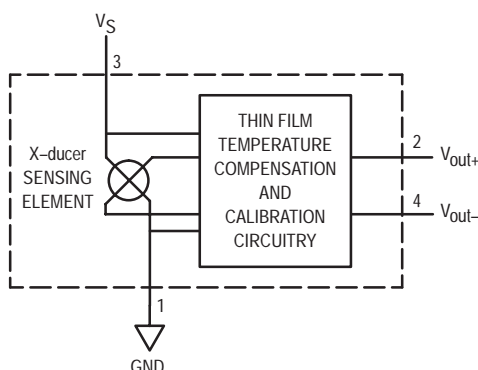

Figure 1. Temperature Compensated Pressure Sensor Schematic

VOLTAGE OUTPUT versus APPLIED DIFFERENTIAL PRESSURE

The differential voltage output of the X-ducer is directly proportional to the differential pressure applied.

The output voltage of the differential or gauge sensor increases with increasing pressure applied to the pressure side (P1) relative to the vacuum side (P2). Similarly, output voltage increases as increasing vacuum is applied to the vacuum side (P2) relative to the pressure side (P1).

Preferred devices are Motorola recommended choices for future use and best overall value.

X-ducer is a trademark of Motorola, Inc.

MPXM2053 SERIES

Motorola Preferred Device

0 to 50 kPa (0 to 7.25 psi)
40 mV FULL SCALE SPAN
(TYPICAL)

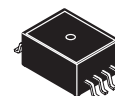

SCALE 2:1

CASE 1320
MPAK, STYLE 1

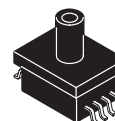

SCALE 2:1

CASE 1320A
MPAK, STYLE 1

PIN NUMBER

1	Gnd	3	V _S
2	+V _{out}	4	-V _{out}



MPXM2053 SERIES

MAXIMUM RATINGS

Rating	Symbol	Value	Unit
Overpressure ⁽⁸⁾ (P1 > P2)	P _{max}	200	kPa
Storage Temperature	T _{stg}	-40 to +125	°C
Operating Temperature	T _A	-40 to +125	°C

OPERATING CHARACTERISTICS (V_S = 10 Vdc, T_A = 25°C unless otherwise noted, P1 > P2)

Characteristic	Symbol	Min	Typ	Max	Unit
Pressure Range ⁽¹⁾	P _{OP}	0	—	50	kPa
Supply Voltage ⁽²⁾	V _S	—	10	16	Vdc
Supply Current	I _o	—	6.0	—	mAdc
Full Scale Span ⁽³⁾	V _{FSS}	38.5	40	41.5	mV
Offset ⁽⁴⁾	V _{off}	-1.0	—	1.0	mV
Sensitivity	ΔV/ΔP	—	0.8	—	mV/kPa
Linearity ⁽⁵⁾	—	-0.6	—	0.4	%V _{FSS}
Pressure Hysteresis ⁽⁵⁾ (0 to 50 kPa)	—	—	±0.1	—	%V _{FSS}
Temperature Hysteresis ⁽⁵⁾ (-40°C to +125°C)	—	—	±0.5	—	%V _{FSS}
Temperature Effect on Full Scale Span ⁽⁵⁾	TCV _{FSS}	-2.0	—	2.0	%V _{FSS}
Temperature Effect on Offset ⁽⁵⁾	TCV _{off}	-1.0	—	1.0	mV
Input Impedance	Z _{in}	1000	—	2500	Ω
Output Impedance	Z _{out}	1400	—	3000	Ω
Response Time ⁽⁶⁾ (10% to 90%)	t _R	—	1.0	—	ms
Warm-Up	—	—	20	—	ms
Offset Stability ⁽⁹⁾	—	—	TBD	—	%V _{FSS}

MECHANICAL CHARACTERISTICS

Characteristic	Symbol	Min	Typ	Max	Unit
Common Mode Line Pressure ⁽⁷⁾	—	—	—	200	kPa

NOTES:

- 1.0 kPa (kiloPascal) equals 0.145 psi.
- Device is ratiometric within this specified excitation range. Operating the device above the specified excitation range may induce additional error due to device self-heating.
- Full Scale Span (V_{FSS}) is defined as the algebraic difference between the output voltage at full rated pressure and the output voltage at the minimum rated pressure.
- Offset (V_{off}) is defined as the output voltage at the minimum rated pressure.
- Accuracy (error budget) consists of the following:
 - Linearity: Output deviation from a straight line relationship with pressure, using end point method, over the specified pressure range.
 - Temperature Hysteresis: Output deviation at any temperature within the operating temperature range, after the temperature is cycled to and from the minimum or maximum operating temperature points, with zero differential pressure applied.
 - Pressure Hysteresis: Output deviation at any pressure within the specified range, when this pressure is cycled to and from the minimum or maximum rated pressure, at 25°C.
 - TcSpan: Output deviation at full rated pressure over the temperature range of 0 to 85°C, relative to 25°C.
 - TcOffset: Output deviation with minimum rated pressure applied, over the temperature range of 0 to 85°C, relative to 25°C.
- Response Time is defined as the time for the incremental change in the output to go from 10% to 90% of its final value when subjected to a specified step change in pressure.
- Common mode pressures beyond specified may result in leakage at the case-to-lead interface.
- Exposure beyond these limits may cause permanent damage or degradation to the device.
- Offset stability is the product's output deviation when subjected to 1000 hours of Pulsed Pressure, Temperature Cycling with Bias Test.

LINEARITY

Linearity refers to how well a transducer's output follows the equation: $V_{out} = V_{off} + \text{sensitivity} \times P$ over the operating pressure range. There are two basic methods for calculating nonlinearity: (1) end point straight line fit (see Figure 2) or (2) a least squares best line fit. While a least squares fit gives the "best case" linearity error (lower numerical value), the calculations required are burdensome.

Conversely, an end point fit will give the "worst case" error (often more desirable in error budget calculations) and the calculations are more straightforward for the user. Motorola's specified pressure sensor linearities are based on the end point straight line method measured at the midrange pressure.

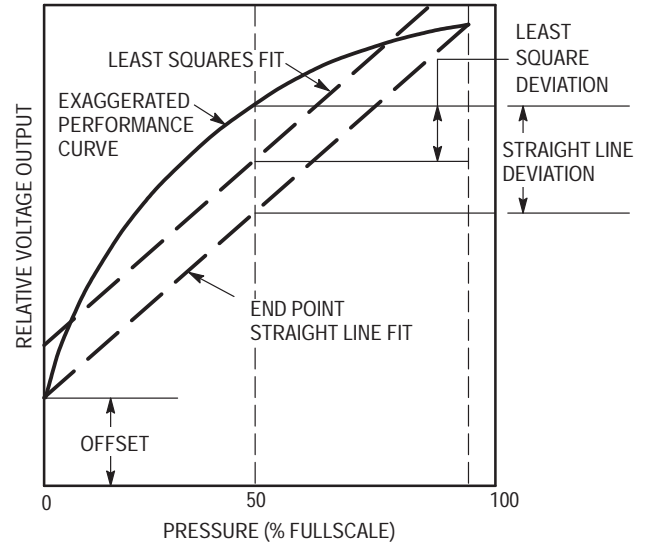

Figure 2. Linearity Specification Comparison

ON-CHIP TEMPERATURE COMPENSATION and CALIBRATION

Figure 3 shows the minimum, maximum and typical output characteristics of the MPXM2053 series at 25°C. The output is directly proportional to the differential pressure and is essentially a straight line.

A silicone gel isolates the die surface and wire bonds from the environment, while allowing the pressure signal to be transmitted to the silicon diaphragm.

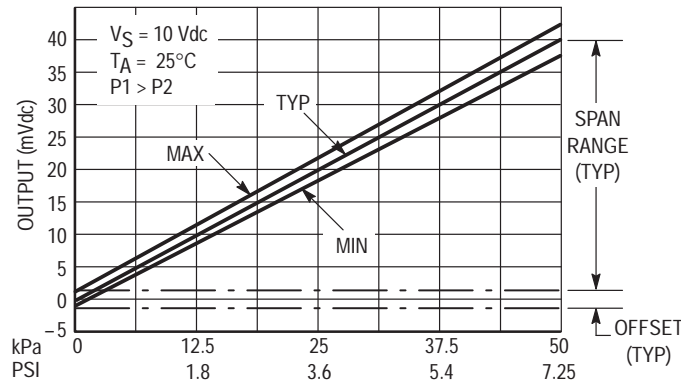
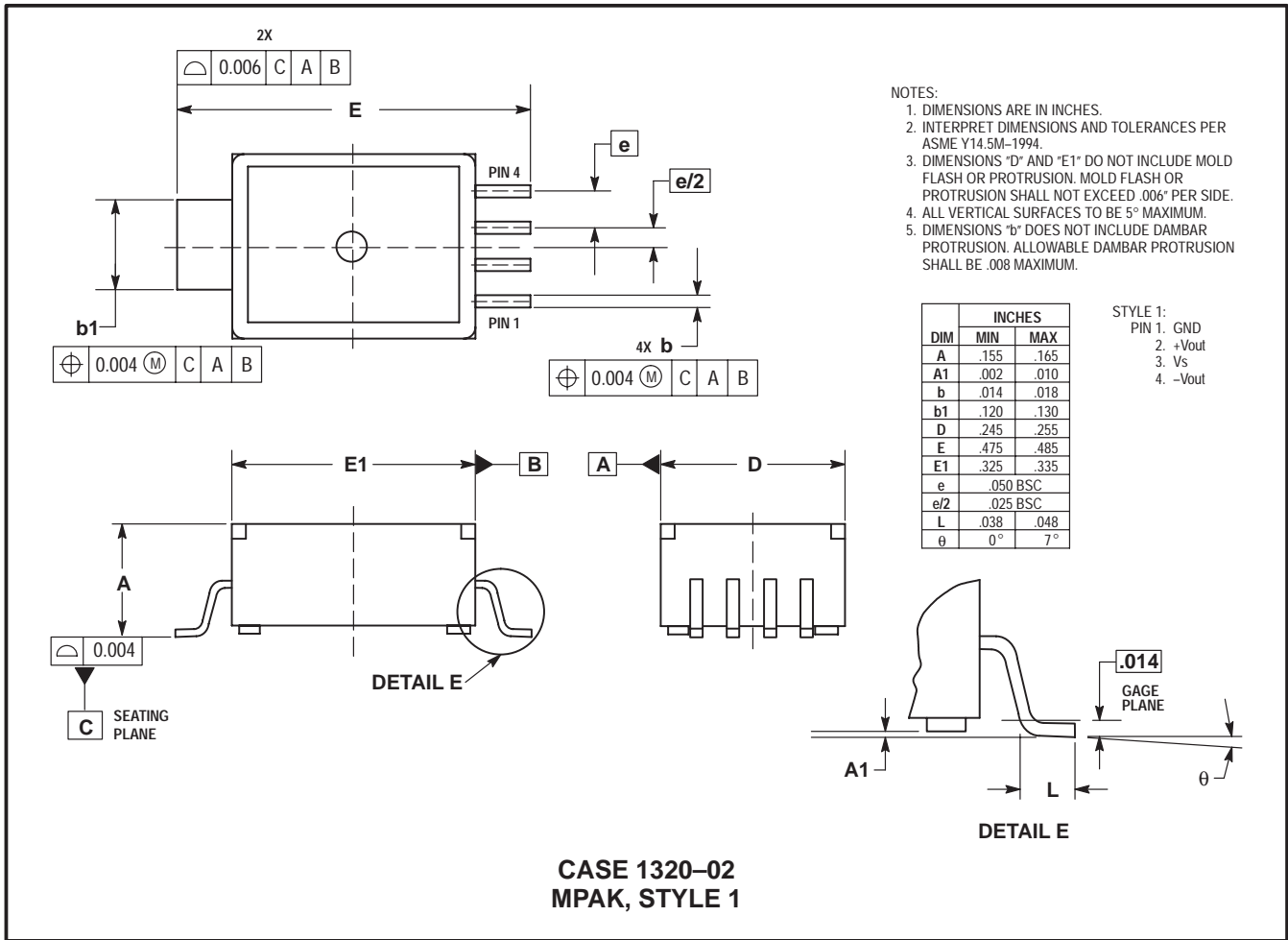

Figure 3. Output versus Pressure Differential

ORDERING INFORMATION	
Device Type	Options
MPXM2053D	Non-ported
MPXM2053DT1	Non-ported, Tape and Reel
MPXM2053GS	Ported
MPXM2053GST1	Ported, Tape and Reel

PACKAGE DIMENSIONS



PACKAGE DIMENSIONS

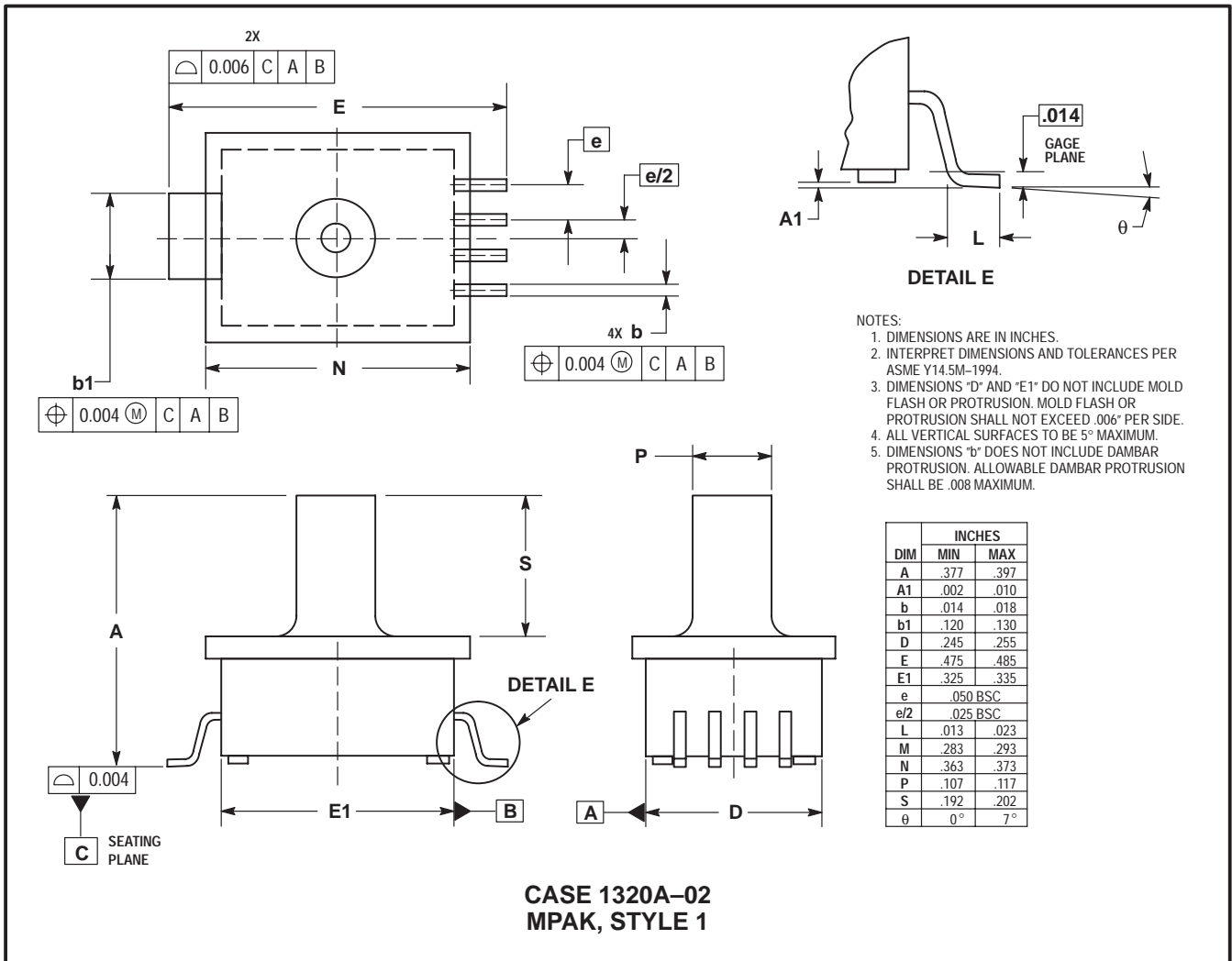

NOTES

NOTES

MPXM2053 SERIES

Motorola reserves the right to make changes without further notice to any products herein. Motorola makes no warranty, representation or guarantee regarding the suitability of its products for any particular purpose, nor does Motorola assume any liability arising out of the application or use of any product or circuit, and specifically disclaims any and all liability, including without limitation consequential or incidental damages. "Typical" parameters which may be provided in Motorola data sheets and/or specifications can and do vary in different applications and actual performance may vary over time. All operating parameters, including "Typicals" must be validated for each customer application by customer's technical experts. Motorola does not convey any license under its patent rights nor the rights of others. Motorola products are not designed, intended, or authorized for use as components in systems intended for surgical implant into the body, or other applications intended to support or sustain life, or for any other application in which the failure of the Motorola product could create a situation where personal injury or death may occur. Should Buyer purchase or use Motorola products for any such unintended or unauthorized application, Buyer shall indemnify and hold Motorola and its officers, employees, subsidiaries, affiliates, and distributors harmless against all claims, costs, damages, and expenses, and reasonable attorney fees arising out of, directly or indirectly, any claim of personal injury or death associated with such unintended or unauthorized use, even if such claim alleges that Motorola was negligent regarding the design or manufacture of the part. Motorola and  are registered trademarks of Motorola, Inc. Motorola, Inc. is an Equal Opportunity/Affirmative Action Employer.

How to reach us:

USA/EUROPE/Locations Not Listed: Motorola Literature Distribution;
P.O. Box 5405, Denver, Colorado 80217. 1-303-675-2140 or 1-800-441-2447

JAPAN: Motorola Japan Ltd.; SPS, Technical Information Center, 3-20-1,
Minami-Azabu, Minato-ku, Tokyo 106-8573 Japan. 81-3-3440-3569

Technical Information Center: 1-800-521-6274

ASIA/PACIFIC: Motorola Semiconductors H.K. Ltd.; Silicon Harbour Centre,
2, Dai King Street, Tai Po Industrial Estate, Tai Po, N.T., Hong Kong.
852-26668334

HOME PAGE: <http://www.motorola.com/sensors/>

