

# RCB005

## 5 Bit Voltage Regulator Module (VRM) for Pentium® II Processors

For 5V Power Supply

### Features

- Programmable 1.3V to 3.5V output
- Output current to 15A
- 5-bit digital input selects output voltage
- Typical efficiency > 82%
- DC output accuracy within  $\pm 60\text{mV}$
- Current limiting short-circuit protection
- Power Good output
- Output Enable function
- Excellent transient response
- Meets Intel VRM specifications

### Applications

- Pentium II Klamath VRM
- Next generation Pentium II VRM

### Description

The RCB005 is a programmable DC-DC VRM designed to deliver the selectable processor core voltage required by Pentium II microprocessors. This VRM converts the +5V power supply voltage to the voltage required by the CPU. The RCB005 takes full advantage of Raytheon's RC5051 programmable DC-DC controller IC, utilizing synchronous architecture for maximum efficiency. This VRM integrates a 5-bit DAC function, Power Good, and Output Enable features. The result is a VRM with a minimum number of components that achieves high reliability at a competitive cost.

The RCB005 provides an extremely well regulated selectable output voltage from 1.3V to 3.5V. Voltage selection is accomplished through a 5-bit digital input. The Power Good output provides a logic LOW when an out-of-tolerance voltage is detected at the VRM output. Other features include high efficiency, short-circuit and over-voltage protection, output enable, and low package weight. The RCB005 VRM module is designed as a point-of-load converter for Pentium II processors, minimizing the distribution losses normally occurring when drawing high currents from a centralized power supply.

### Block Diagram

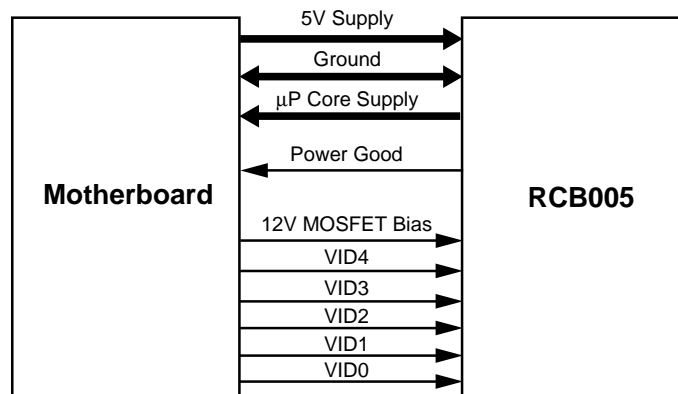

65-RCB005-1

## Pin Orientation — Top View

(Socket: AMPMOD2 532956-7 or equivalent)

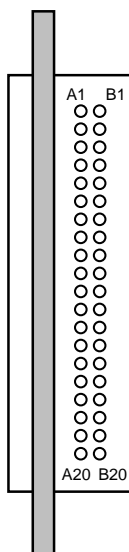

65-RCB005-2

Table 1. RCB005 Pin Definitions

Pin #	Row A	Row B
1	5Vin	5Vin
2	5Vin	5Vin
3	5Vin	5Vin
4	12Vin	12Vin
5	12Vin	NC <sup>1</sup>
6	NC <sup>1</sup>	OUTEN
7	VID0	VID1
8	VID2	VID3
9	VID4	PWRGD
10	VCCCORE	Vss
11	Vss	VCCCORE
12	VCCCORE	Vss
13	Vss	VCCCORE
14	VCCCORE	Vss
15	Vss	VCCCORE
16	VCCCORE	Vss
17	Vss	VCCCORE
18	VCCCORE	Vss
19	Vss	VCCCORE
20	VCCCORE	Vss

**Note:**

1. Not used on module; no current is drawn.

## VRM Connector Pin Reference

Pin Description	Input/Output	Function
5Vin	I	Primary module supply voltage.
12Vin	I	MOSFET bias supply voltage.
OUTEN (Output Enable) Open collector TTL input.	I	If OUTEN = HIGH (floating), output enabled. If OUTEN = LOW, output disabled and PWRGD output LOW.
VID0 to VID4 (Voltage Identification Code) Open collector TTL inputs.	I	These five signals are used to indicate the voltage required by the processor. See Table 2.
PWRGD (Power Good) Open collector TTL output.	O	If PWRGD = HIGH, output voltage within specifications. If PWRGD = LOW, output voltage not within $\pm 10\%$ of nominal. The PWRGD output will change to the proper state within 5ms of the output coming into or going out of its specified range.
VCCCORE	O	Processor core voltage.
Vss	I, O	Ground.

**Table 2. Output Voltage vs. Voltage Identification Code**

VID4	VID3	VID2	VID1	VID0	Nominal Voltage to CPU (V <sub>CC</sub> CORE)
0	1	1	1	1	1.30V
0	1	1	1	0	1.35V
0	1	1	0	1	1.40V
0	1	1	0	0	1.45V
0	1	0	1	1	1.50V
0	1	0	1	0	1.55V
0	1	0	0	1	1.60V
0	1	0	0	0	1.65V
0	0	1	1	1	1.70V
0	0	1	1	0	1.75V
0	0	1	0	1	1.80V
0	0	1	0	0	1.85V
0	0	0	1	1	1.90V
0	0	0	1	0	1.95V
0	0	0	0	1	2.00V
0	0	0	0	0	2.05V

VID4	VID3	VID2	VID1	VID0	Nominal Voltage to CPU (V <sub>CC</sub> CORE)
1	1	1	1	1	2.0V
1	1	1	1	0	2.1V
1	1	1	0	1	2.2V
1	1	1	0	0	2.3V
1	1	0	1	1	2.4V
1	1	0	1	0	2.5V
1	1	0	0	1	2.6V
1	1	0	0	0	2.7V
1	0	1	1	1	2.8V
1	0	1	1	0	2.9V
1	0	1	0	1	3.0V
1	0	1	0	0	3.1V
1	0	0	1	1	3.2V
1	0	0	1	0	3.3V
1	0	0	0	1	3.4V
1	0	0	0	0	3.5V

**Note:**

- "0" indicates processor pin is tied to 0V (V<sub>SS</sub>)  
 "1" indicates it is tied to 5V or is open.

## Electrical Specifications

5Vin = +5V, 12Vin = +12V, TA = 0°C to 60°C, VCCORE = 2.8V, and airflow of 100LFM, unless otherwise specified.

Parameter		Test Conditions	Min.	Typ.	Max.	Units
<b>Input Specifications</b>						
Primary Module Supply, 5Vin			4.75	5	5.25	V
MOSFET Bias Supply, 12Vin			11.4	12	12.6	V
<b>Output Specifications</b>						
Output Voltage Range, VCCORE		See Table 2	1.3		3.5	V
Output Voltage Regulation	Steady State <sup>2</sup>	VCCORE = 2.8V, ICCORE, Max = 14.2A	2.74	2.80	2.90	V
	Transient <sup>3</sup>	VCCORE = 2.8V, ICCORE = 1.0 to 14.2A	2.67	2.80	2.93	
Output Voltage Regulation	Steady State <sup>2</sup>	VCCORE = 2.0V, ICCORE, Max = 11.1A	1.94	2.0	2.06	V
	Transient <sup>3</sup>	VCCORE = 2.0V, ICCORE = 0.5 to 11.1A	1.90	2.0	2.10	
Output Current, ICCORE			0.3		15	A
Initial Voltage Setpoint		ICCCORE = 6A, TA = 25°C		±20		mV
Load Regulation		ICCCORE = 0.8A to 14.2A		-40		mV
Line Regulation		5Vin = 4.75V to 5.25V		±2		mV
Output Ripple		20MHz BW, ICCORE = 14.2A		20		mVp-p
Output Temperature Drift				+10		mV
Efficiency		ICCCORE = 0.5A	40	67		%
		ICCCORE = 14A	80	82		
Turn-on Response Time					10	ms
<b>General Specifications</b>						
Switching Frequency				300		kHz
Short Circuit Protection				18		A

### Notes:

1. The voltage tolerance is measured at the DC-DC converter Header Output on the motherboard.
2. The Steady State Voltage Regulation includes Initial Voltage Setpoint, DC load regulation, Output Ripple and temperature drift, measured with a digital voltmeter with 1mV resolution. ICCORE, MIN = 0.1A unless otherwise specified.
3. The output voltage is measured using the Intel provided EMT Tester (Rev. 1.0). It is assumed that a minimum of 20 x 0.1µF ceramic capacitors are placed directly next to the CPU to provide adequate high-speed decoupling. Additional bulk capacitors may be required as closely as possible to the CPU socket on the motherboard when using the VRM. See Application Bulletin AB 5 for details.

# Transient Plots

Transient Plot, Vout=2.8V, Iload=14.2A to 0.8A  
RCB005 VRM

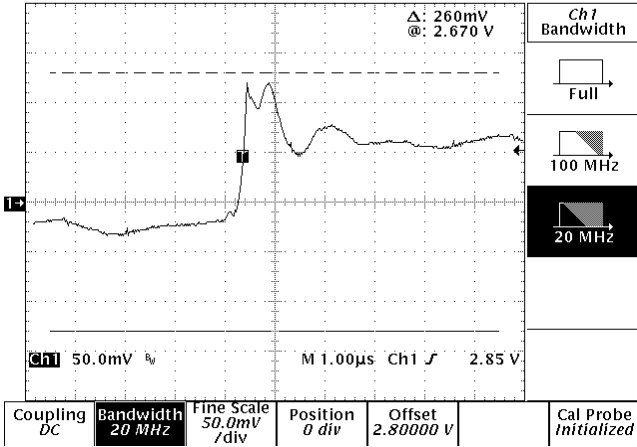

Transient Plot, Vout=2.8V, Iload=0.5A to 14.2A  
RCB005 VRM

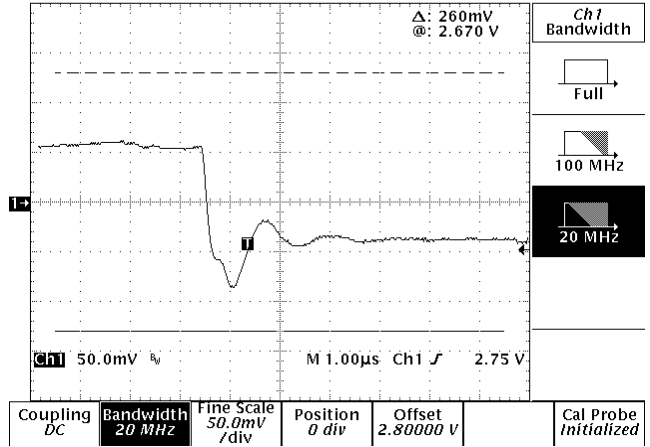

Transient Plot Vout=2.0V, Iload=11.1A to 0.5A  
RCB005 VRM

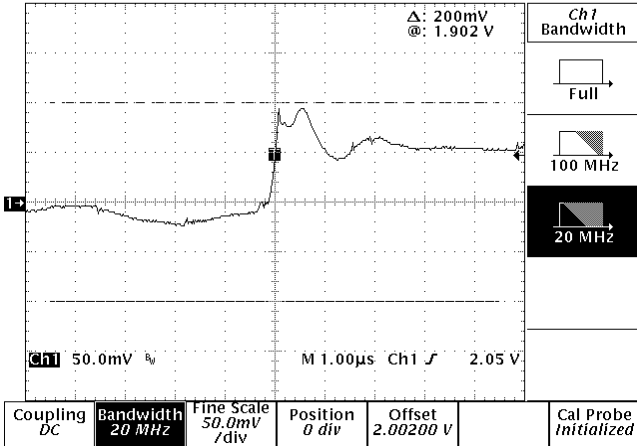

Transient Plot Vout=2.0V, Iload=0.5A to 11.1A  
RCB005 VRM

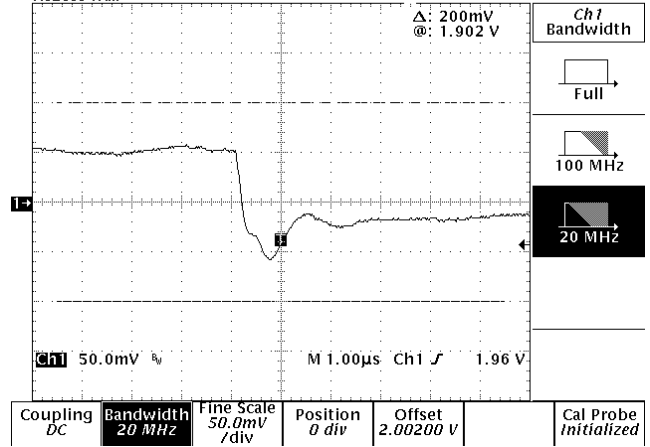

**Notes:**

# Mechanical Dimensions (mm)

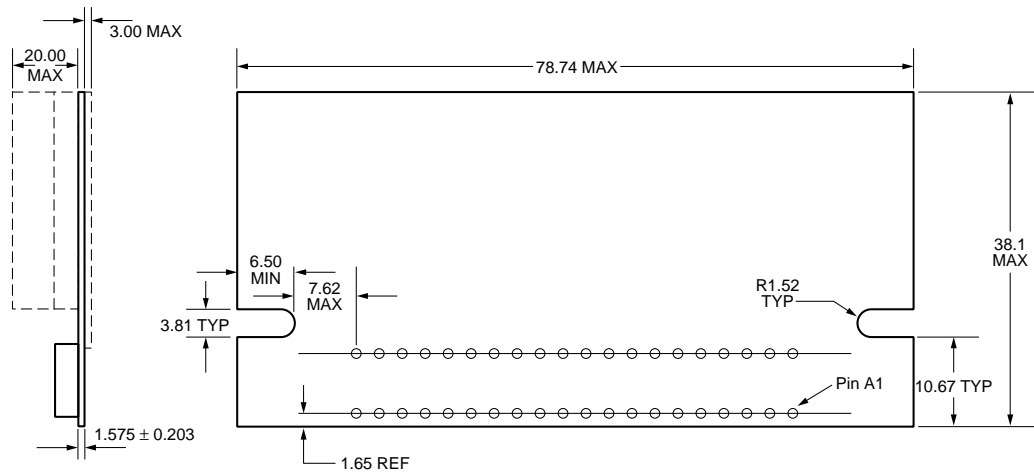

## Ordering Information

Part Number	Input	Output Current
RCB005	5V DC	15A

### LIFE SUPPORT POLICY

FAIRCHILD'S PRODUCTS ARE NOT AUTHORIZED FOR USE AS CRITICAL COMPONENTS IN LIFE SUPPORT DEVICES OR SYSTEMS WITHOUT THE EXPRESS WRITTEN APPROVAL OF THE PRESIDENT OF FAIRCHILD SEMICONDUCTOR CORPORATION. As used herein:

1. Life support devices or systems are devices or systems which, (a) are intended for surgical implant into the body, or (b) support or sustain life, and (c) whose failure to perform when properly used in accordance with instructions for use provided in the labeling, can be reasonable expected to result in a significant injury of the user.
2. A critical component in any component of a life support device or system whose failure to perform can be reasonably expected to cause the failure of the life support device or system, or to affect its safety or effectiveness.

**Fairchild Semiconductor Corporation**  
Americas  
Customer Response Center  
Tel:1-888-522-5372

**Fairchild Semiconductor Europe**  
Fax: +49 (0) 1 80-530 85 86  
Email: europe.support@nsc.com  
Deutsch Tel: +49 (0) 8 141-35-0  
English Tel: +44 (0) 1 793-85-68-56  
Italy Tel: +39 (0) 2 57 5631

**Fairchild Semiconductor Hong Kong Ltd.**  
13th Floor, Straight Block,  
Ocean Center, 5 Canto Rd.  
Tsimshatsui, Kowloon  
Hong Kong  
Tel:+852 2737-7200  
Fax:+852 2314-0061

**National Semiconductor Japan Ltd.**  
Tel:81-3-5620-6175  
Fax:81-3-5620-6179